

Input voltage up to 80 VDC
Single output of 5.1 - 36 VDC
No input to output isolation

- High efficiency up to 96%
- Wide input voltage range
- Low input to output differential voltage
- Very good dynamic properties
- Input undervoltage lock-out
- External output voltage adjustment and inhibit
- Two temperature ranges
- Continuous no-load and short-circuit proof
- No derating

Safety according to IEC/EN 60950



Summary

The PSC series of positive switching regulators is designed as power supply modules for electronic systems. Their major advantages include a high level of efficiency that remains virtually constant over the entire input voltage range, high reliability, low ripple and excellent dynamic response.

Modules with input voltages up to 80 V are specially designed for secondary switched and battery driven applications. The case design allows operation at nominal load up to 71 °C without additional cooling.

Model Selection and Key Data

Table 1: Type survey

Output voltage $V_{o\ nom}$ [V]	Output current $I_{o\ nom}$ [A]	Input voltage range V_i [V] ¹	Input voltage $V_{i\ nom}$ [V]	Efficiency ²		Type designation	Options	Superseded old type (phased-out)
				η_{min} [%]	η_{typ} [%]			
5.1	12	7 - 40	20	82	83	PSC 5A12-7iR	-9, L, P, C, D	PSR 512-7
5.1	10	8 - 80	40	76	79	PSC 5A10-7iR		PSR 510-7
12	8	15 - 80	40	88	89	PSC 128-7iR		PSR 128-7
15	8	19 - 80	40	90	91	PSC 158-7iR		PSR 158-7
24	8	29 - 80	50	93	94	PSC 248-7iR		PSR 248-7
36	8	42 - 80	60	95	96	PSC 368-7iR		PSR 368-7

¹ See: *Electrical Input Data*: $\Delta V_{i\ o\ min}$ (min. differential voltage $V_i - V_o$).

² Efficiency at $V_{i\ nom}$ and $I_{o\ nom}$.

Non standard input/output configurations or special custom adaptations are available on request.

Table of Contents

	Page	Page	
Summary	1	Electromagnetic Compatibility (EMC)	7
Model Selection and Key Data	1	Immunity to Environmental Conditions	8
Part Number Description	2	Mechanical Data	9
Functional Description	2	Safety and Installation Instructions	10
Electrical Input Data	3	Description of Options	11
Electrical Output Data	4	Accessories	12
Auxiliary Functions	6	EC-Declaration of Conformity	13

Part Number Description

Positive switching regulator in case C03	PSC	_____	PSC	_____
Nominal output voltage in volt (5A for 5.1 V)	5A - 36	_____	12	_____
Nominal output current in ampere	8 - 12	_____	8	_____
Operational ambient temperature range T_A				
-25 to 71°C	-7	_____	-7	_____
-40 to 71°C (option)	-9	_____	-9	_____
Input filter (option)	L	_____	L	_____
Inhibit input	i	_____	i	_____
Control input for output voltage adjustment ¹	R	_____	R	_____
Potentiometer ¹ (option)	P	_____	P	_____
Thyristor crowbar (option)	C	_____	C	_____
Input/output voltage monitor (option)	D/D1	_____	D	_____

¹ Feature R excludes option P and vice versa.

Example: PSC 128-7LiPC = A positive switching regulator with a 12 V, 8 A output, ambient temperature range of -25 to 71°C, input filter, inhibit input, output adjust potentiometer and thyristor crowbar.

Functional Description

The switching regulators are designed using the buck converter topology. See also: *Technical Information: Topologies*. The input is not electrically isolated from the output. During the on period of the switching transistor, current is transferred to the output and energy is stored in the output choke in the form of flux. During the off period, this energy forces the current to continue flowing through the output, to the load and back through the freewheeling diode. Regulation is accomplished by varying the on to off duty ratio of the power switch.

These regulators are ideal for a wide range of applications, where input to output isolation is not necessary, or where already provided by an external front end (e.g. a transformer with rectifier). To optimise customer's needs, additional options and accessories are available.

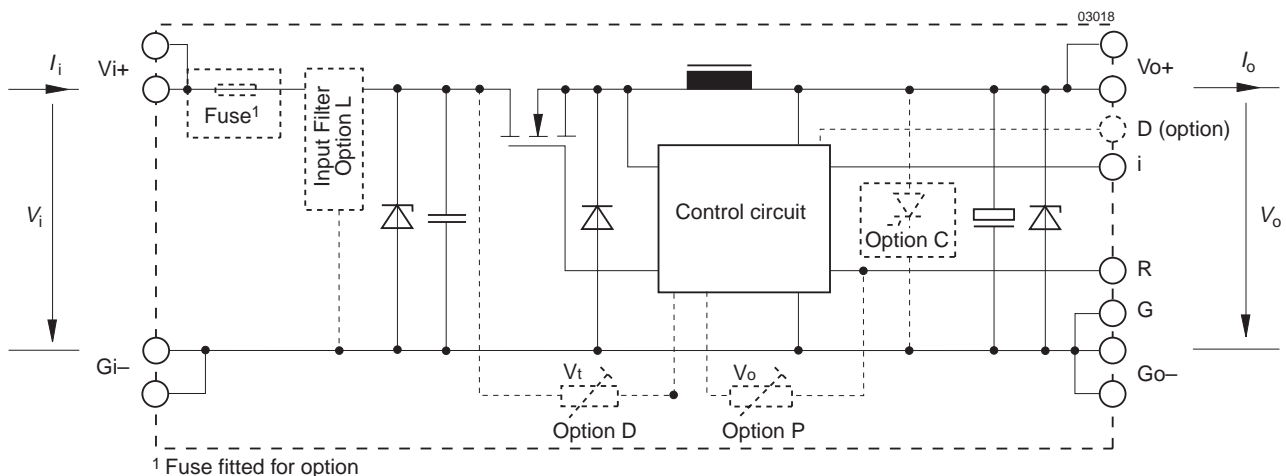

Fig. 1
Block diagram

Electrical Input Data

General Conditions: $T_A = 25^\circ\text{C}$, unless T_C is specified

Table 2a: Input data

Input			PSC 5A12			PSC 5A10			PSC 128			Unit
Characteristics	Conditions		min	typ	max	min	typ	max	min	typ	max	
V_i	Operating input voltage	$I_o = 0 - I_{o\text{ nom}}$ $T_{C\text{ min}} - T_{C\text{ max}}$	7		40	8		80	15		80	VDC
$\Delta V_{i\text{ o min}}$	Min. diff. voltage $V_i - V_o$ ¹				1.9			2.9			3	
$V_{i\text{ o}}$	Undervoltage lock-out				6.3			7.3			7.3	
$I_{i\text{ o}}$	No load input current	$I_o = 0, V_{i\text{ min}} - V_{i\text{ max}}$			45			40			35	mA
$I_{i\text{ nr p}}$	Peak value of inrush current	$V_{i\text{ nom}}$ without option L			150			250			250	A
$t_{i\text{ nr r}}$	Rise time				5			5			5	μs
$t_{i\text{ nr h}}$	Time to half-value				40			40			40	
$I_{i\text{ nr p}}$	Peak value of inrush current	$V_{i\text{ nom}}$ with option L			250			350			350	A
$t_{i\text{ nr r}}$	Rise time				25			25			25	μs
$t_{i\text{ nr h}}$	Time to half-value				125			125			125	
$u_{i\text{ RFI}}$	Input RFI level, EN 55011/22 0.15 - 30 MHz	$V_{i\text{ nom}}, I_{o\text{ nom}}$ with option L ²			B			B			B	

Table 2b: Input data

Input			PSC 158			PSC 248			PSC 368			Unit
Characteristics	Conditions		min	typ	max	min	typ	max	min	typ	max	
V_i	Operating input voltage	$I_o = 0 - I_{o\text{ nom}}$ $T_{C\text{ min}} - T_{C\text{ max}}$	19		80	29		80	42		80	VDC
$\Delta V_{i\text{ o min}}$	Min. diff. voltage $V_i - V_o$ ¹				4			5			6 ¹	
$V_{i\text{ o}}$	Undervoltage lock-out				7.3			12			19	
$I_{i\text{ o}}$	No load input current	$I_o = 0, V_{i\text{ min}} - V_{i\text{ max}}$			35			35			40	mA
$I_{i\text{ nr p}}$	Peak value of inrush current	$V_{i\text{ nom}}$ without option L			250			250			250	A
$t_{i\text{ nr r}}$	Rise time				5			5			5	μs
$t_{i\text{ nr h}}$	Time to half-value				40			40			40	
$I_{i\text{ nr p}}$	Peak value of inrush current	$V_{i\text{ nom}}$ with option L			350			350			350	A
$t_{i\text{ nr r}}$	Rise time				25			25			25	μs
$t_{i\text{ nr h}}$	Time to half-value				125			125			125	
$u_{i\text{ RFI}}$	Input RFI level, EN 55011/22 0.15 - 30 MHz	$V_{i\text{ nom}}, I_{o\text{ nom}}$ with option L ²			B			B			B	

¹ The minimum differential voltage $\Delta V_{i\text{ o min}}$ between input and output increases linearly by 0 to 1 V between $T_A = 46^\circ\text{C}$ and 71°C ($T_C = 70^\circ\text{C}$ and 95°C)

² With additional external input capacitor $C_e = 120\ \mu\text{F}/100\ \text{V}$ (e.g. Nichicon PF series, or equivalent).

External Input Circuitry

The sum of the lengths of the supply lines to the source or to the nearest capacitor $\geq 100\ \mu\text{F}$ (a + b) should not exceed 5 m unless option L is fitted. This option is recommended in order to prevent power line oscillations and reduce superimposed interference voltages. See also: *Technical Information: Application Notes*.

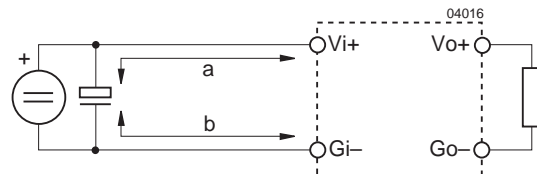

Fig. 2
Switching regulator with long supply lines.

Electrical Output Data

General Conditions:

- $T_A = 25^\circ\text{C}$, unless T_C is specified
- With R or option P, output voltage $V_o = V_{o\text{ nom}}$ at $I_{o\text{ nom}}$

Table 3a: Output data

Output			PSC 5A12			PSC 5A10			PSC 128			Unit
Characteristics		Conditions	min	typ	max	min	typ	max	min	typ	max	
V_o	Output voltage		$V_{i\text{ nom}}, I_{o\text{ nom}}$			5.07	5.13	5.07	5.13	11.93	12.07	V
I_o	Output current ¹		$V_{i\text{ min}} - V_{i\text{ max}}$			0	12.0	0	10.0	0	8.0	A
I_{oL}	Output current limitation response		$T_C\text{ min} - T_C\text{ max}$			12.0	15.6	10.0	13.0	8.0	10.4	
u_o	Output voltage noise	Switching freq.	$V_{i\text{ nom}}, I_{o\text{ nom}}$			25	30	25	30	50	90	mV _{pp}
		Total	IEC/EN 61204 ² BW = 20 MHz			29	34	29	34	54	94	
ΔV_{oU}	Static line regulation		$V_{i\text{ min}} - V_{i\text{ max}}, I_{o\text{ nom}}$			30	45	30	45	50	75	mV
ΔV_{oI}	Static load regulation		$V_{i\text{ nom}}, I_o = 0 - I_{o\text{ nom}}$			20	25	20	25	30	35	
$u_{o d}$	Dynamic load regulation	Voltage deviat.	$V_{i\text{ nom}}$			130		130		130		μs
t_d		Recovery time	$I_{o\text{ nom}} \leftrightarrow \frac{1}{3} I_{o\text{ nom}}$ IEC/EN 61204 ²			40		50		60		
α_{Uo}	Temperature coefficient $\Delta V_o / \Delta T_C (T_C\text{ min} - T_C\text{ max})$		$V_{i\text{ min}} - V_{i\text{ max}}$			± 1		± 1		± 2		mV/K
			$I_o = 0 - I_{o\text{ nom}}$			± 0.02		± 0.02		± 0.02		%/K

Table 3b: Output data

Output			PSC 158			PSC 248			PSC 368			Unit
Characteristics		Conditions	min	typ	max	min	typ	max	min	typ	max	
V_o	Output voltage		$V_{i\text{ nom}}, I_{o\text{ nom}}$			14.91	15.09	23.86	24.14	35.78	36.22	V
I_o	Output current ¹		$V_{i\text{ min}} - V_{i\text{ max}}$			0	8.0	0	8.0	0	8.0	A
I_{oL}	Output current limitation response		$T_C\text{ min} - T_C\text{ max}$			8.0	10.4	8.0	10.4	8.0	10.4	
u_o	Output voltage noise	Switching freq.	$V_{i\text{ nom}}, I_{o\text{ nom}}$			50	90	55	150	80	190	mV _{pp}
		Total	IEC/EN 61204 ² BW = 20 MHz			54	94	60	155	85	195	
ΔV_{oU}	Static line regulation		$V_{i\text{ min}} - V_{i\text{ max}}, I_{o\text{ nom}}$			70	100	150	220	200	270	mV
ΔV_{oI}	Static load regulation		$V_{i\text{ nom}}, I_o = 0 - I_{o\text{ nom}}$			30	45	120	160	125	160	
$u_{o d}$	Dynamic load regulation	Voltage deviat.	$V_{i\text{ nom}}$			130		150		220		μs
t_d		Recovery time	$I_{o\text{ nom}} \leftrightarrow \frac{1}{3} I_{o\text{ nom}}$ IEC/EN 61204 ²			60		80		100		
α_{Uo}	Temperature coefficient $\Delta V_o / \Delta T_C (T_C\text{ min} - T_C\text{ max})$		$V_{i\text{ min}} - V_{i\text{ max}}$			± 3		± 5		± 8		mV/K
			$I_o = 0 - I_{o\text{ nom}}$			± 0.02		± 0.02		± 0.02		%/K

¹ See also: *Thermal Considerations*.

² See: *Technical Information: Measuring and Testing*.

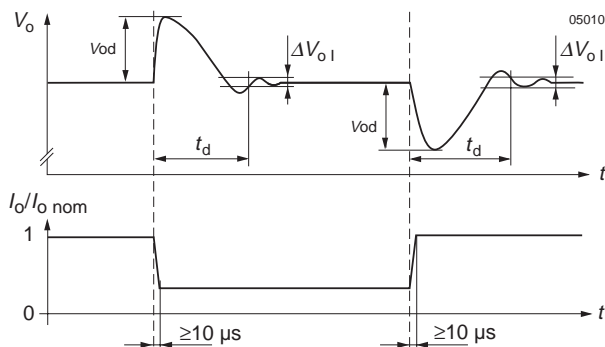

Fig. 3
Dynamic load regulation.

Thermal Considerations

When a switching regulator is located in free, quasi-stationary air (convection cooling) at a temperature $T_A = 71^\circ\text{C}$ and is operated at its nominal output current $I_o \text{ nom}$, the case temperature T_C will be about 95°C after the warm-up phase, measured at the *Measuring point of case temperature T_C* (see: *Mechanical Data*).

Under practical operating conditions, the ambient temperature T_A may exceed 71°C , provided additional measures (heat sink, fan, etc.) are taken to ensure that the case temperature T_C does not exceed its maximum value of 95°C .

Example: Sufficient forced cooling allows $T_{A \text{ max}} = 85^\circ\text{C}$. A simple check of the case temperature T_C ($T_C \leq 95^\circ\text{C}$) at full load ensures correct operation of the system.

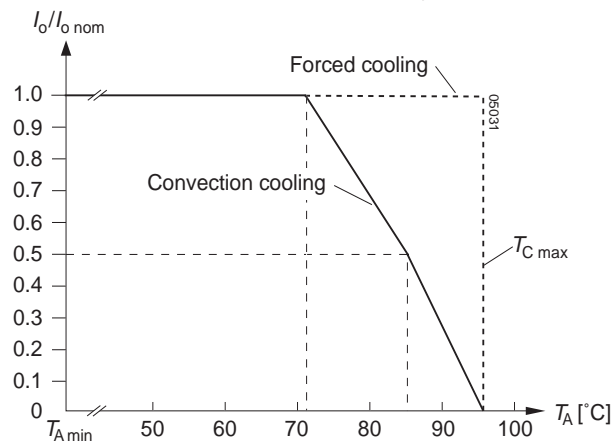

Fig. 4
Output current derating versus temperature

Output Protection

A voltage suppressor diode which in worst case conditions fails into a short circuit (or a thyristor crowbar, option C) protects the output against an internally generated overvoltage. Such an overvoltage could occur due to a failure of either the control circuit or the switching transistor. The output protection is not designed to withstand externally applied overvoltages. The user should ensure that systems with Power-One power supplies, in the event of a failure, do not result in an unsafe condition (fail-safe).

Parallel and Series Connection

Outputs of equal nominal voltages can be parallel-connected. However, the use of a single unit with higher output power, because of its power dissipation, is always a better solution.

In parallel-connected operation, one or several outputs may operate continuously at their current limit knee-point which will cause an increase of the heat generation. Consequently, the max. ambient temperature value should be reduced by 10 K.

Outputs can be series-connected with any other module. In series-connection the maximum output current is limited by the lowest current limitation. Electrically separated source voltages are needed for each module!

Short Circuit Behaviour

A constant current limitation circuit holds the output current almost constant whenever an overload or a short circuit is applied to the regulator's output. It acts self-protecting and recovers – in contrary to the fold back method – automatically after removal of the overload or short circuit condition.

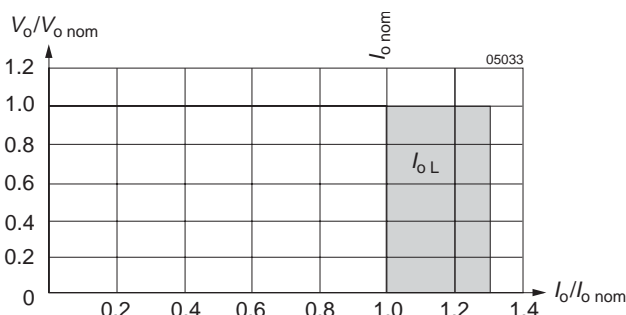

Fig. 5
Overload, short-circuit behaviour V_o versus I_o .

Auxiliary Functions

i Inhibit for Remote On and Off

Note: With open i-input, output is enabled ($V_o = \text{on}$)

The inhibit input allows the switching regulator output to be disabled via a control signal. In systems with several units, this feature can be used, for example, to control the activation sequence of the regulators by a logic signal (TTL, CMOS, etc.). An output voltage overshoot will not occur when switching on or off.

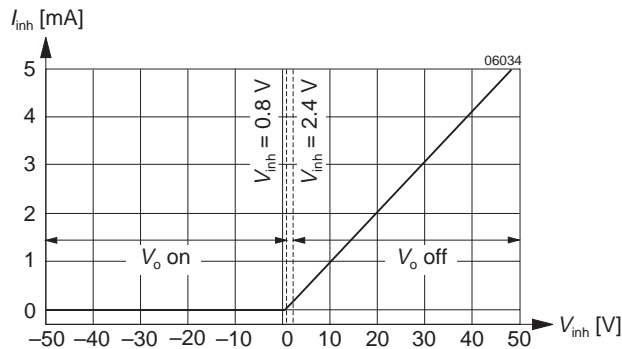

Fig. 6
Typical inhibit current I_{inh} versus inhibit voltage V_{inh}

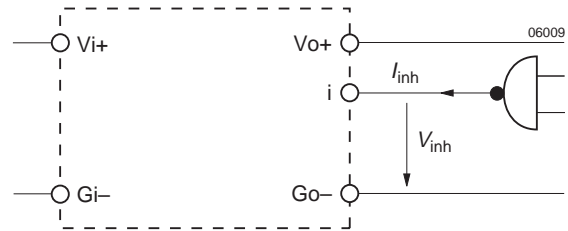

Fig. 7
Definition of I_{inh} and V_{inh}

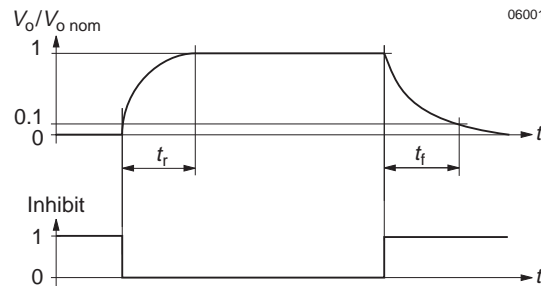

Fig. 8
Output response as a function of inhibit signal

Table 4: Inhibit characteristics

Characteristics		Conditions	min	typ	max	Unit
V_{inh}	Inhibit input voltage to keep regulator output voltage -	$V_i = V_{i \min} - V_{i \max}$ $T_C = T_{C \min} - T_{C \max}$	$V_o = \text{on}$	-50	+0.8	VDC
			$V_o = \text{off}$	+2.4	+50	
t_r	Switch-on time after inhibit command	$V_i = V_{i \text{ nom}}$		5		ms
t_f	Switch-off time after inhibit command	$R_L = V_o \text{ nom} / I_o \text{ nom}$		10		
$I_{i \text{ inh}}$	Input current when inhibited	$V_i = V_{i \text{ nom}}$		10		mA

R Control for Output Voltage Adjustment

Note: With open R input, $V_o \approx V_o \text{ nom}$. R excludes option P. (For superseded PSR types $V_o \approx 1.08 \cdot V_o \text{ nom}$)

The output voltage V_o can either be adjusted with an external voltage (V_{ext}) or with an external resistor (R_1 or R_2). The adjustment range is 0 - 108% of $V_o \text{ nom}$. The minimum differential voltage $\Delta V_{io \text{ min}}$ between input and output (see: *Electrical Input Data*) should be maintained. Undervoltage lock-out = Minimum input voltage.

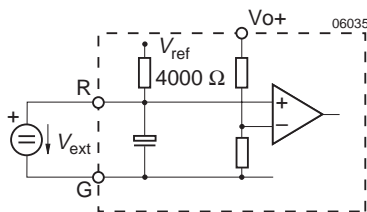

Fig. 9
Voltage adjustment with V_{ext} between R and G (Go-)

a) $V_o = 0 - 108\% V_o \text{ nom}$, using V_{ext} between R and G (Go-)

$$V_{ext} \approx 2.5 \text{ V} \cdot \frac{V_o}{V_o \text{ nom}} \quad V_o \approx V_o \text{ nom} \cdot \frac{V_{ext}}{2.5 \text{ V}}$$

Caution: To prevent damage V_{ext} should not exceed 20 V, nor be negative and R_2 should never be less than 47 k Ω .

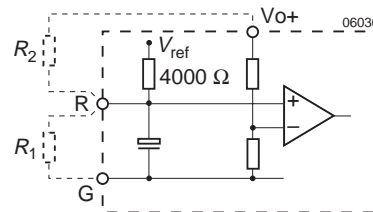

Fig. 10
Voltage adjustment with external resistor R_1 or R_2

b) $V_o = 0 - 100\% V_{o\text{ nom}}$, using R_1 between R and G (Go-):

$$R_1 \approx \frac{4000 \Omega \cdot V_o}{V_{o\text{ nom}} - V_o} \quad V_o \approx \frac{V_{o\text{ nom}} \cdot R_1}{R_1 + 4000 \Omega}$$

c) $V_o = V_{o\text{ nom}} - V_{o\text{ max}}$, using R_2 between R and Vo+:

$$V_{o\text{ max}} = V_{o\text{ nom}} + 8\%$$

$$R_2 \approx \frac{4000 \Omega \cdot V_o \cdot (V_{o\text{ nom}} - 2.5 \text{ V})}{2.5 \text{ V} \cdot (V_o - V_{o\text{ nom}})}$$

$$V_o \approx \frac{V_{o\text{ nom}} \cdot 2.5 \text{ V} \cdot R_2}{2.5 \text{ V} \cdot (R_2 + 4000 \Omega) - V_{o\text{ nom}} \cdot 4000 \Omega}$$

LED Output Voltage Indicator

A yellow output indicator LED shines when the output voltage is higher than approx. 3 V.

Electromagnetic Compatibility (EMC)

Electromagnetic Immunity

General condition: Case not earthed.

Table 5: Immunity type tests

Phenomenon	Standard ¹	Class Level	Coupling mode ²	Value applied	Waveform	Source Imped.	Test procedure	In oper.	Per-form. ³
1 MHz burst disturbance	IEC 60255-22-1	III	i/o, i/c, o/c	2500 V _p	400 damped 1 MHz waves/s	200 Ω	2 s per coupling mode	yes	A ⁵
			+i/-i, +o/-o	1000 V _p					
Voltage surge	IEC 60571-1		i/c, +i/-i	800 V _p	100 μs	100 Ω	1 pos. and 1 neg. voltage surge per coupling mode	yes	B
				1500 V _p	50 μs				
				3000 V _p	5 μs				
				4000 V _p	1 μs				
				7000 V _p	100 ns				
Electrostatic discharge	IEC/EN 61000-4-2	3	contact discharge to case	6000 V _p	1/50 ns	330 Ω	10 positive and 10 negative discharges	yes	A ⁴
Electromagnetic field	IEC/EN 61000-4-3	2	antenna	3 V/m	AM 80% 1 kHz		80 - 1000 MHz	yes	A
Electrical fast transients/burst	IEC/EN 61000-4-4	3	i/c, +i/-i	2000 V _p	bursts of 5/50 ns 5 kHz rep. rate transients with 15 ms burst duration and a 300 ms period	50 Ω	60 s positive 60 s negative bursts per coupling mode	yes	A ^{4,5}
		4		4000 V _p					B ^{4,5}
Surge	IEC/EN 61000-4-5	3	i/c	2000 V _p	1.2/50 μs	12 Ω	5 pos. and 5 neg. surges per coupling mode	yes	B ^{4,5}
			+i/-i	1000 V _p		2 Ω			
Conducted disturbances	IEC/EN 61000-4-6	3	i, o, signal wires	140 dBμV (10 VAC)	AM 80% 1 kHz	150 Ω	0.15 - 80 MHz	yes	A

¹ For related and previous standards see: *Technical Information: Safety & EMC*. ² i = input, o = output, c = case.

³ A = Normal operation, no deviation from specifications, B = Normal operation, temporary deviation from specs possible.

⁴ Option L necessary. ⁵ With option C, manual reset might be necessary.

Electromagnetic Emission

For emission levels refer to: *Electrical Input Data*.

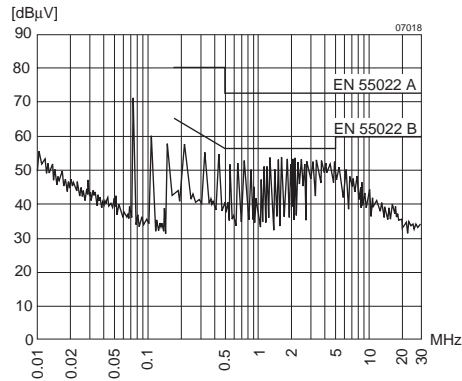

Fig. 11
Typical disturbance voltage (quasi-peak) at the input according to EN 55011/22 measured at $V_{i\text{nom}}$ and $I_{o\text{nom}}$.

Immunity to Environmental Conditions

Table 6: Mechanical stress

Test Method		Standard	Test Conditions		Status
Ca	Damp heat steady state	IEC/DIN 60068-2-3 MIL-STD-810D section 507.2	Temperature: Relative humidity: Duration:	40 ±2 °C 93 +2/-3 % 56 days	Unit not operating
Ea	Shock (half-sinusoidal)	IEC/EN/DIN 60068-2-27 MIL-STD-810D section 516.3	Acceleration amplitude: Bump duration: Number of bumps:	100 g _n = 981 m/s ² 6 ms 18 (3 each direction)	Unit operating
Eb	Bump (half-sinusoidal)	IEC/EN/DIN 60068-2-29 MIL-STD-810D section 516.3	Acceleration amplitude: Bump duration: Number of bumps:	40 g _n = 392 m/s ² 6 ms 6000 (1000 each direction)	Unit operating
Fc	Vibration (sinusoidal)	IEC/EN/DIN 60068-2-6 MIL-STD-810D section 514.3	Acceleration amplitude: Frequency (1 Oct/min): Test duration:	0.35 mm (10 - 60 Hz) 5 g _n = 49 m/s ² (60 - 2000 Hz) 10 - 2000 Hz 7.5 h (2.5 h each axis)	Unit operating
Fda	Random vibration wide band Reproducibility high	IEC 60068-2-35 DIN 40046 part 23	Acceleration spectral density: Frequency band: Acceleration magnitude: Test duration:	0.05 g ² /Hz 20 - 500 Hz 4.9 g _{rms} 3 h (1 h each axis)	Unit operating
Kb	Salt mist, cyclic (sodium chloride NaCl solution)	IEC/EN/DIN 60068-2-52	Concentration: Duration: Storage: Storage duration: Number of cycles:	5% (30°C) 2 h per cycle 40°C, 93% rel. humidity 22 h per cycle 3	Unit not operating

Table 7: Temperature specifications, valid for air pressure of 800 - 1200 hPa (800 - 1200 mbar)

Temperature		Standard -7		Option -9		Unit
Characteristics	Conditions	min	max	min	max	
T _A	Ambient temperature	Operational ¹		-40	71	°C
T _C	Case temperature	-25	95	-40	95	
T _S	Storage temperature	Non operational		-55	100	

¹ See: *Thermal Considerations*

Table 8: MTBF and device hours

MTBF	Ground Benign	Ground Fixed		Ground Mobile	Device Hours ¹
MTBF acc. to MIL-HDBK-217F	T _C = 40°C	T _C = 40°C	T _C = 70°C	T _C = 50°C	2 800 000 h
	660 000	143 000 h	81 000 h	68 000 h	

¹ Statistical values, based on an average of 4300 working hours per year and in general field use

Mechanical Data

Dimensions in mm. Tolerances ± 0.3 mm unless otherwise specified.



09023

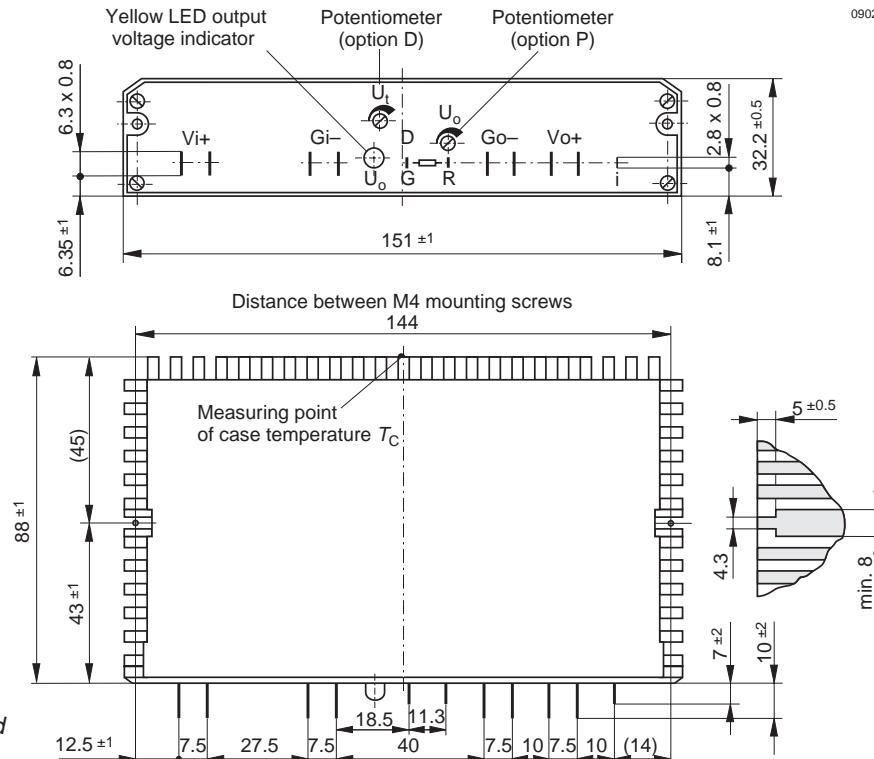

Fig. 12
Case C03, weight 440 g
Aluminium, black finish and
self cooling

Safety and Installation Instructions

Installation Instruction

Installation of the switching regulators must strictly follow the national safety regulations in compliance with the enclosure, mounting, creepage, clearance, casualty, markings and segregation requirements of the end-use application.

Check for hazardous voltages before altering any connections. Connections can be made using fast-on or soldering technique.

The input and the output circuit are not separated, i.e. the negative path is internally interconnected!

The units should be connected to a secondary circuit.

Do not open the module.

Ensure that a unit failure (e.g. by an internal short-circuit) does not result in a hazardous condition. See also: *Safety of operator accessible output circuit.*

Cleaning Agents

In order to avoid possible damage, any penetration of cleaning fluids is to be prevented, since the power supplies are not hermetically sealed.

Protection Degree

The protection degree is IP 20.

Standards and Approvals

All switching regulators are UL recognized according to UL 1950, UL 1012 and EN 60950, UL recognized for Canada to CAN/CSA C22.2 No. 234-M90.

The units have been evaluated for:

- Building in,
- Operational insulation from input to output and input/output to case,
- The use in an overvoltage category II environment,
- The use in a pollution degree 2 environment.

The switching regulators are subject to manufacturing surveillance in accordance with the above mentioned UL and CSA and with ISO 9001 standards.

Isolation

Electric strength test voltage between input interconnected with output against case: 750 VDC, 1 s.

This test is performed in the factory as routine test in accordance with EN50116, IEC/EN 60950 and UL 1950 and should not be repeated in the field. Power-One will not honour any guarantee claims resulting from electric strength field tests.

Safety of Operator Accessible Output Circuit

If the output circuit of a switching regulator is operator-accessible, it shall be an SELV circuit according to IEC/EN 60950 related safety standards

The following table shows some possible installation configurations, compliance with which causes the output circuit of the switching regulator to be an SELV circuit according to IEC/EN 60950 up to a nominal output voltage of 30 V, or 48 V if option C is fitted.

However, it is the sole responsibility of the installer or user to assure the compliance with the relevant and applicable safety regulations.

More information is given in: *Technical Information: Safety & EMC*.

Table 9: Insulation concept leading to an SELV output circuit

Conditions Front end				Switching regulator	Result
Supply voltage	Minimum required grade of isolation, to be provided by the AC-DC front end, including mains supplied battery charger	Maximum DC output voltage from the front end ¹	Minimum required safety status of the front end output circuit	Measures to achieve the specified safety status of the output circuit	Safety status of the switching regulator output circuit
Battery supply, considered as secondary circuit	Double or Reinforced	≤60 V	SELV circuit	None	SELV circuit
		>60 V	Earthed hazardous voltage secondary circuit ²	Input fuse ³ non accessible case ⁵	Earthed SELV circuit
			Unearthed hazardous voltage secondary circuit ⁵	Input fuse ³ and unearthed, non accessible case ⁵	Unearthed SELV circuit
			Hazardous voltage secondary circuit	Input fuse ³ and earthed output circuit ⁴ and non accessible case ⁵	Earthed SELV circuit
Mains ≤250 V AC	Basic	≤60 V	Earthed SELV circuit ⁴	None	Earthed SELV circuit
			ELV circuit	Input fuse ³ and earthed output circuit ⁴ and non accessible case ⁵	
	>60 V	Hazardous voltage secondary circuit	Input fuse ³ and earthed output circuit ⁴ and non accessible case ⁵		
		Double or reinforced	≤60 V	SELV circuit	
>60 V	Double or reinforced insulated unearthed hazardous voltage secondary circuit ⁵		Input fuse ³ and unearthed and non accessible case ⁵	Unearthed SELV circuit	

¹ The front end output voltage should match the specified input voltage range of the switching regulator.

² The conductor to the Gi- terminal of the switching regulator has to be connected to earth by the installer according to the relevant safety standard, e.g. IEC/EN 60950.

³ The installer shall provide an approved fuse (slow blow type with the lowest current rating suitable for the application, max. 12.5 A) in a non-earthed input conductor directly at the input of the switching regulator. If Vo+ is earthed, insert the fuse in the Gi- line. For UL's purpose, the fuse needs to be UL-listed. If option C is fitted, a suitable fuse is already built-in in the Vi+ line.

⁴ The earth connection has to be provided by the installer according to the relevant safety standard, e.g. IEC/EN 60950.

⁵ Has to be insulated from earth by double or reinforced insulation according to the relevant safety standard, based on the maximum output voltage from the front end.

Description of Options

-9 Extended Temperature Range

The operational ambient temperature range is extended to $T_A = -40$ to 71°C . ($T_C = -40$ to 95°C , $T_S = -55$ to 100°C .)

P Potentiometer

Option P excludes R function. The output voltage V_O can be adjusted with a screwdriver in the range from 0.92 - 1.08 of the nominal output voltage $V_{O\text{nom}}$.

However, the minimum differential voltage $\Delta V_{i\text{omin}}$ between input and output voltages as specified in: *Electrical Input Data* should be maintained.

L Input Filter

Option L is recommended to reduce superimposed interference voltages and to prevent oscillations, if input lines exceed approx. 5 m in total length. The fundamental wave (approx. 120 kHz) of the reduced interference voltage between V_{i+} and G_{i-} has, with an input line inductance of $5\ \mu\text{H}$, a maximum magnitude of 4 mVAC. A reduction can be achieved by insertion of a capacitor across the input (e.g. plastic foil between V_{i+} and G_{i-}).

The input impedance of the switching regulator at 120 kHz is about $3.5\ \Omega$. The harmonics are small in comparison with the fundamental wave. See also: *Electrical Input Data: RFI*.

With option L, the maximum permissible additionally superimposed ripple u_i of the input voltage (rectifier mode) at a specified input frequency f_i has the following values:

Units with max input voltage 40 V:

$$u_{i\text{max}} = 12\ V_{pp}\ \text{at}\ 100\ \text{Hz}\ \text{or}\ V_{pp} = 1200\ \text{Hz}/f_i \cdot 1\text{V}$$

Units with max input voltage 80 V:

$$u_{i\text{max}} = 22\ V_{pp}\ \text{at}\ 100\ \text{Hz}\ \text{or}\ V_{pp} = 2200\ \text{Hz}/f_i \cdot 1\text{V}$$

C Crowbar

This option is recommended to protect the load against power supply malfunction, but it is not designed to sink external currents.

A fixed-value monitoring circuit checks the output voltage V_O . When the trigger voltage V_{Oc} is reached, the thyristor crowbar triggers and disables the output. It may be deactivated by removal of the input voltage. In case of a switching transistor defect, an internal fuse prevents excessive current.

Note: As a central overvoltage protection device, the crowbar is usually connected to the external load via distributed inductance of the lines. For this reason, the overvoltage at the load can temporarily exceed the trigger voltage V_{Oc} . Depending on the application, further decentralized overvoltage protection elements may have to be used additionally.

Table 10: Crowbar trigger levels

Characteristics		Conditions	5.1 V		12 V		15 V		24 V		36 V		Unit
			min	max	min	max	min	max	min	max	min	max	
V_{Oc}	Trigger voltage	$V_{i\text{min}} - V_{i\text{max}}$ $I_o = 0 - I_{o\text{nom}}$	5.8	6.8	13.5	16	16.5	19	27	31	40	45.5	V
t_s	Delay time	$T_{C\text{min}} - T_{C\text{max}}$	1.5		1.5		1.5		1.5		1.5		μs

D Save Data Input Undervoltage Monitor

Note: Output instead of input undervoltage monitor is available on request (Option D1).

Terminal D and G_{o-} are connected to a normally conducting field effect transistor (JFET). The switching characteristics of the option D output are shown in fig. Definition of V_1 and V_H . A 0.5 W Zener diode provides protection against overvoltages.

The voltage V_1 can be externally adjusted with a trim potentiometer by means of a screwdriver. The hysteresis V_H of V_1 is $<2\%$. Terminal D stays low for a minimum time $t_{\text{low min}}$, in order to prevent any oscillation. V_1 can be set to a value between $V_{i\text{min}}$ and $V_{i\text{max}}$. Please note that the JFET becomes conductive when V_D increases above 7 V approx.

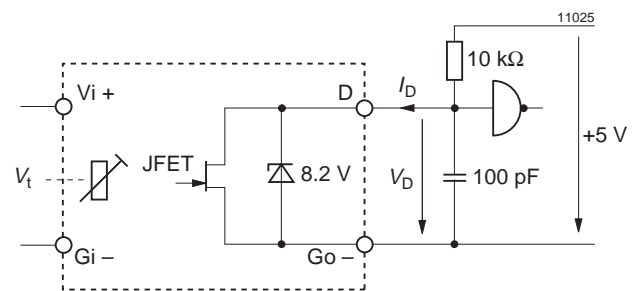

Fig. 13
Test circuit with definition of voltage V_D and current I_D

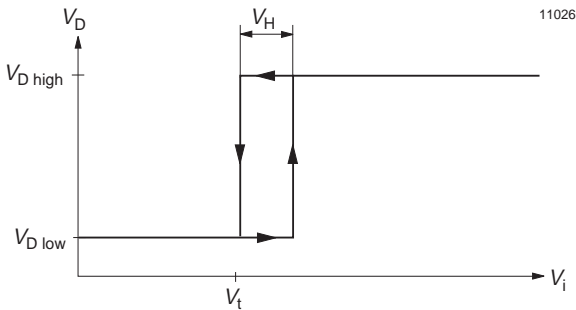

Fig. 14
Definition of V_t and V_H

Data

Table 11: Option D data

Characteristics		Conditions	PSC			Unit
			min	typ	max	
$V_{D\ low}$	Voltage - Terminal D at low impedance	$V_i < V_t, I_D - 2.5\ mA$			0.8	V
$V_{D\ high}$	Voltage - Terminal D at high impedance	$V_i > V_t + V_H, I_D > 25\ \mu A$	4.75			
$t_{low\ min}$	Minimum duration $V_{D\ low}$			30		ms
$t_{D\ t}$	Response time to $V_{D\ low}$			1		μs
$I_{D\ max}$	Maximum current - Terminal D				20	mA

Application examples:

- The signal V_D can be utilized in battery powered systems to provide a warning in case of low batteries.
- In case of power failure, the signal can serve to initiate data save routines.

Accessories

A variety of electrical and mechanical accessories are available including:

- PCB-tags and isolation pads for easy and safe PCB-mounting.
- Ring core chokes for ripple and interference reduction.

For more detailed information please refer to: *Accessories* on the Power-One homepage.



NUCLEAR AND MEDICAL APPLICATIONS - Power-One products are not authorized for use as critical components in life support systems, equipment used in hazardous environments, or nuclear control systems without the express written consent of the respective divisional president of Power-One, Inc.

TECHNICAL REVISIONS - The appearance of products, including safety agency certifications pictured on labels, may change depending on the date manufactured. Specifications are subject to change without notice.

EC Declaration of Conformity

We

Power-One AG
Ackerstrasse 56 CH-8610 Uster

declare under our sole responsibility that all PSx Series switching regulators carrying the CE-mark are in conformity with the provisions of the Low Voltage Directive (LVD) 73/23/EEC of the European Communities.

Conformity with the directive is presumed by conformity with the following harmonized standards:

- EN 61204: 1995 (= IEC 61204: 1993, modified)
Low-voltage power supply devices, d.c. output - Performance characteristics and safety requirements
 - EN 60950: 1992 + A1: 1993 + A2 (= IEC 950 second edition 1991 + A1: 1992 + A2: 1993)
Safety of information technology equipment
-

The installation instructions given in the corresponding data sheet describe correct installation leading to the presumption of conformity of the end product with the LVD. All PSx Series Switching Regulators are components, intended exclusively for inclusion within other equipment by an industrial assembly operation or by professional installers. They must not be operated as stand alone products.

Hence conformity with the Electromagnetic Compatibility Directive 89/336/EEC (EMC Directive) needs not to be declared. Nevertheless, guidance is provided in most product application notes on how conformity of the end product with the indicated EMC standards under the responsibility of the installer can be achieved, from which conformity with the EMC directive can be presumed.

Uster, 14 Oct. 2003

Power-One AG



Rolf Baldauf
Director Engineering



Johann Milavec
Director Projects and IP